











3M™ Versaflo™ Easy Clean Backpack, TR-927

	TR-300+	TR-600	TR-800	S-Series	H-Series	M-Series
						
NIOSH	<input checked="" type="checkbox"/>	<input checked="" type="checkbox"/>	<input checked="" type="checkbox"/>	<input checked="" type="checkbox"/>	<input checked="" type="checkbox"/>	<input checked="" type="checkbox"/>
CE	<input checked="" type="checkbox"/>	<input checked="" type="checkbox"/>	<input checked="" type="checkbox"/>	<input checked="" type="checkbox"/>		<input checked="" type="checkbox"/>

	NIOSH		CE	
	HF	FF	HF	FF
				
BT-63	<input checked="" type="checkbox"/>	<input checked="" type="checkbox"/>	<input checked="" type="checkbox"/>	<input checked="" type="checkbox"/>
BT-64		<input checked="" type="checkbox"/>		

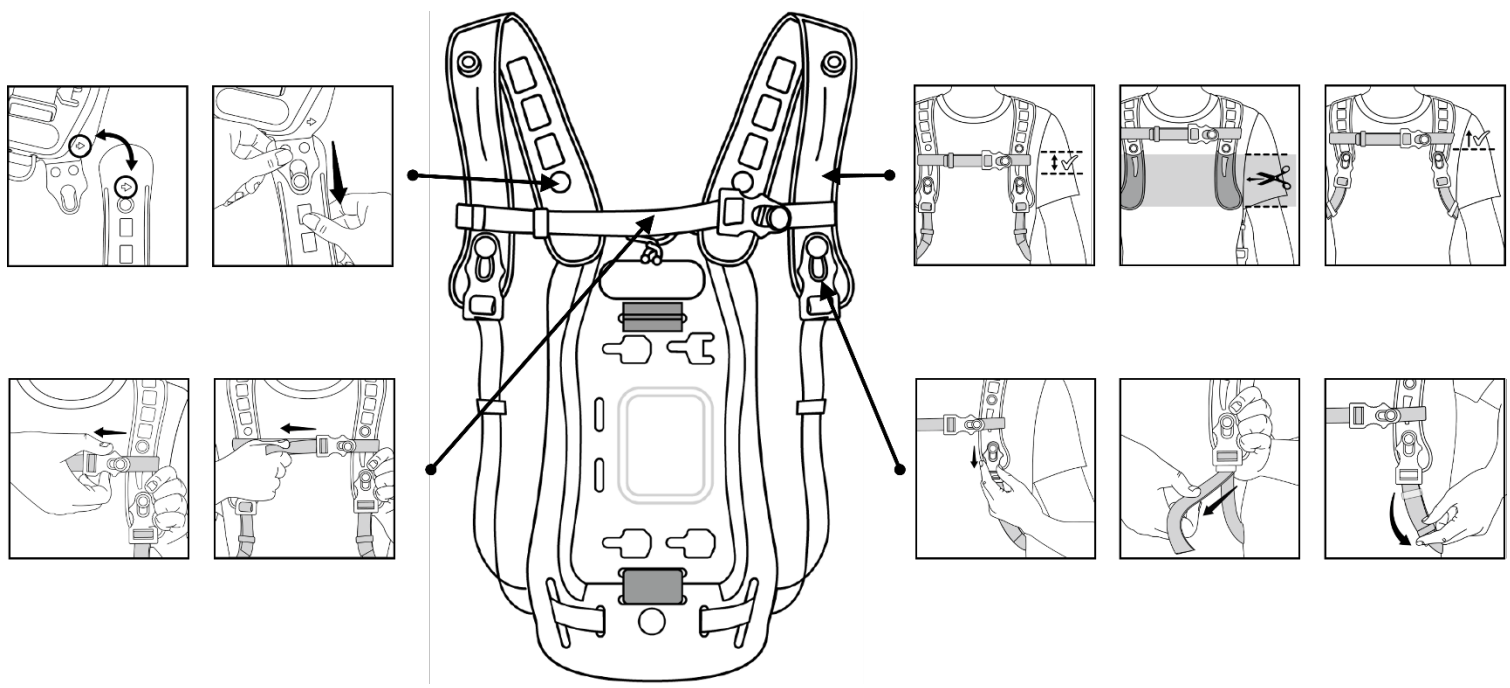

TR-300+

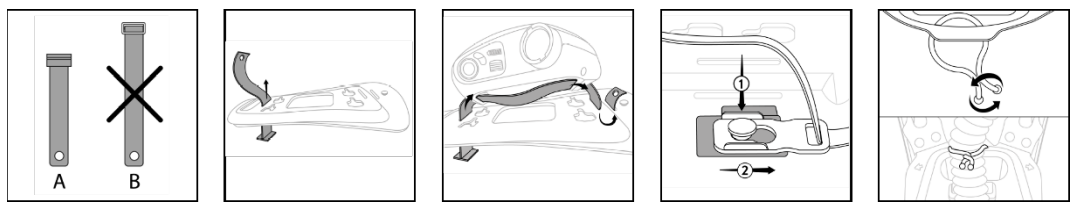

TR-600/800

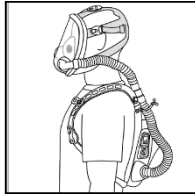
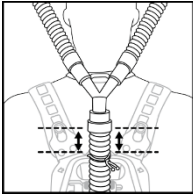
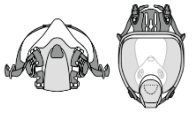
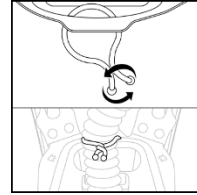
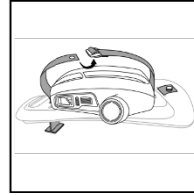
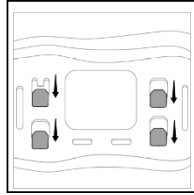
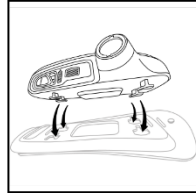
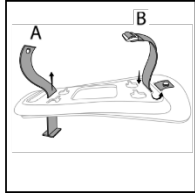
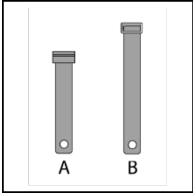
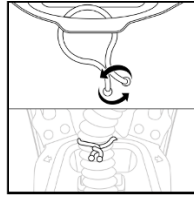
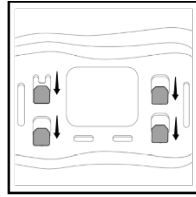
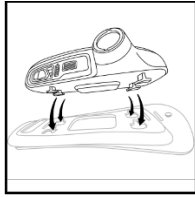
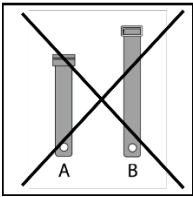

## USER INSTRUCTIONS

### IMPORTANT

Before use, the wearer must read and understand these *User Instructions*. Keep these *User Instructions* for reference. If you have questions regarding this product, contact 3M Technical Service in your region.

Read completely and follow the *User Instructions* for the PAPR system being used with this backpack to complete system assembly, inspection, performance checks, and storage.

### Warnings and Limitations



This component is part of a system that helps protect against certain airborne contaminants. Failure to follow these instructions may reduce respirator performance, expose you to contaminants above the Workplace Exposure Limit (WEL) or Occupational Exposure Limit (OEL) and may result in sickness or death.

Do not use these products around heat, flames, or sparks. Select and wear appropriate protection when exposed to sparks and/or flames. Failure to do so may result in serious injury.

Do not use without filter cover when installed with optional backpack mounting straps.

Always secure loose strap ends and breathing tube to prevent snagging.

### NIOSH –Approval, Cautions, & Limitations

This product is one component of a NIOSH approved respiratory protection system. Refer to the *User Instructions* and/or the *NIOSH Approval Label* provided with the 3M PAPR system for approved configurations and applicable NIOSH Cautions and Limitations.

### Caution

Backpack should be adjusted securely to user. TR-327 or GVP-117 may be used for additional security.



~ 0.74 lbs. (337 grams)  
Polyester/Nylon/Plastic/Stainless Steel



14 °F – 129 °F (-10 °C – 54 °C)

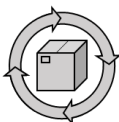

5 yrs.  
< 90% RH  
40 °F – 95 °F (4 °C – 35 °C)

## **FOR MORE INFORMATION**

In United States, contact:

Website: [www.3m.com/workersafety](http://www.3m.com/workersafety)

Technical Assistance: 1-800-243-4630

### **In Canada, contact:**

Website: [www.3M.com/CA/PPESafety](http://www.3M.com/CA/PPESafety)

Technical Assistance: 1-800-267-4414

### **For other 3M products:**

1-800-3M-HELPS or 1-651-737-6501

## **3M Personal Safety Division**

3M Center, Building 0235-02-W-70

St. Paul, MN 55144-1000

3M and Versaflo are trademarks of 3M Company, used under license in Canada.

3M PSD products are occupational use only.

© 3M 2022.